

### Features

- Low Forward Voltage Drop
- Guard Ring Die Construction for Transient Protection
- Ideal for low logic level applications
- Low Capacitance
- Lead Free Product

### Mechanical Data

- Case: SOT-26, Plastic
- Case material - UL Flammability Rating Classification 94V-0
- Moisture Sensitivity: Level 1 per J-STD-020A
- Polarity: See Diagram
- Leads: Matte Tin (Lead Free), Solderable per MIL-STD-202, Method 208
- Marking: Marking Code & Date Code (See Page 3)
- Marking Code: KSR
- Weight: 0.016 grams (approx.)

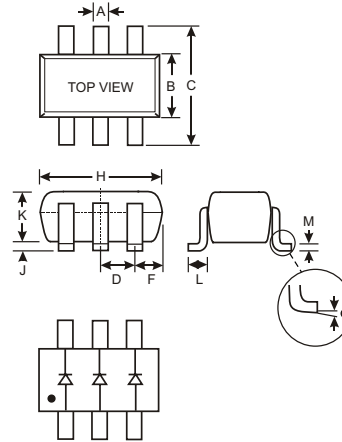

SOT-26			
Dim	Min	Max	Typ
A	0.35	0.50	0.38
B	1.50	1.70	1.60
C	2.70	3.00	2.80
D	—	—	0.95
F	—	—	0.55
H	2.90	3.10	3.00
J	0.013	0.10	0.05
K	1.00	1.30	1.10
L	0.35	0.55	0.40
M	0.10	0.20	0.15
$\alpha$	0°	8°	—
<b>All Dimensions in mm</b>			

### Maximum Ratings @ T<sub>A</sub> = 25°C unless otherwise specified

Characteristic	Symbol	Value	Unit
Peak Repetitive Reverse Voltage Working Peak Reverse Voltage DC Blocking Voltage	V <sub>RRM</sub> V <sub>RWM</sub> V <sub>R</sub>	40	V
RMS Reverse Voltage	V <sub>R(RMS)</sub>	28	V
Forward Continuous Current (Note 2)	I <sub>FM</sub>	30	mA
Non-Repetitive Peak Forward Surge Current @8.3ms Single half sine-wave superimposed on rated load (JEDEC method)	I <sub>FSM</sub>	200	mA
Power Dissipation (Note 2)	P <sub>d</sub>	225	mW
Thermal Resistance, Junction to Ambient Air	R <sub>θJA</sub>	444	°C/W
Operating and Storage Temperature Range	T <sub>j</sub> , T <sub>STG</sub>	-40 to +125	°C

### Electrical Characteristics @ T<sub>A</sub> = 25°C unless otherwise specified

Characteristic	Symbol	Min	Typ	Max	Unit	Test Condition
Reverse Breakdown Voltage (Note 1)	V <sub>(BR)R</sub>	40	—	—	V	I <sub>R</sub> = 10uA
Forward Voltage Drop (Note 1)	V <sub>F</sub>	—	—	370	mV	I <sub>F</sub> = 1mA
Leakage Current (Note 1)	I <sub>R</sub>	—	—	1	μA	V <sub>R</sub> = 10V
Total Capacitance	C <sub>T</sub>	—	2	—	pF	V <sub>R</sub> = 1V f = 1.0 MHz

- Notes: 1. Short duration test pulse to minimize self-heating effect.  
 2. Device mounted on FR-4 PC board with recommended pad layout, which can be found on our website at <http://www.diodes.com/datasheets/ap02001.pdf>.

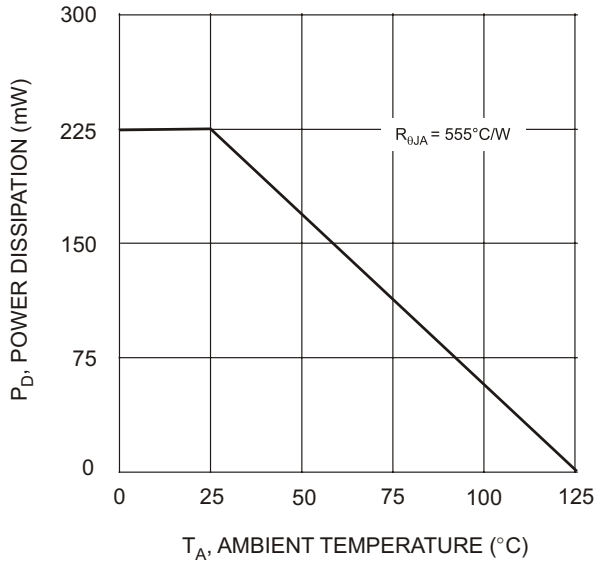

Fig. 1 Derating Curve

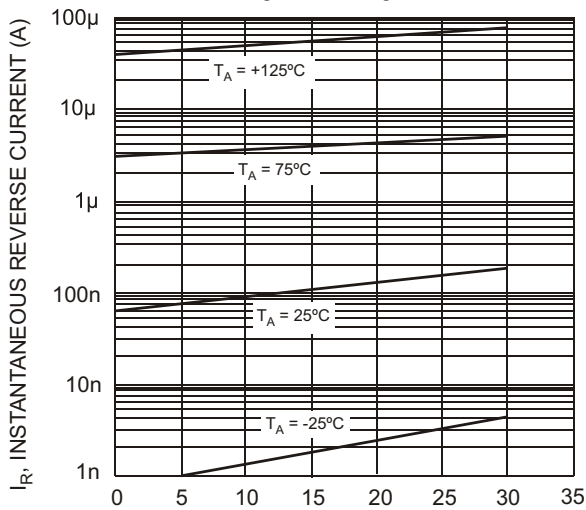

Fig. 3 Typical Reverse Characteristics

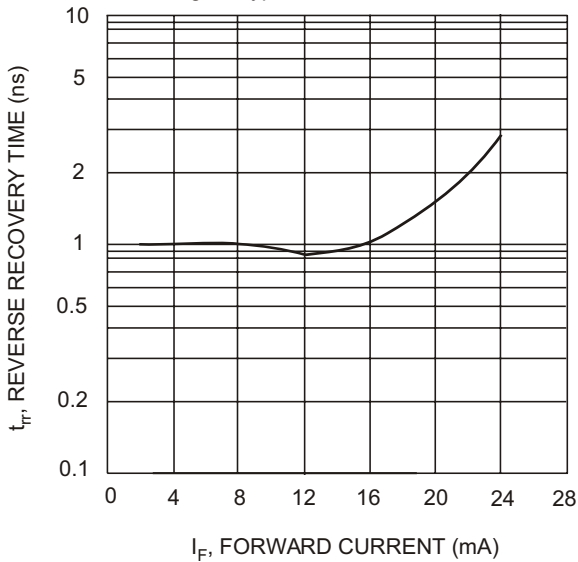

Fig. 5 Typical Reverse Recovery Time Characteristics

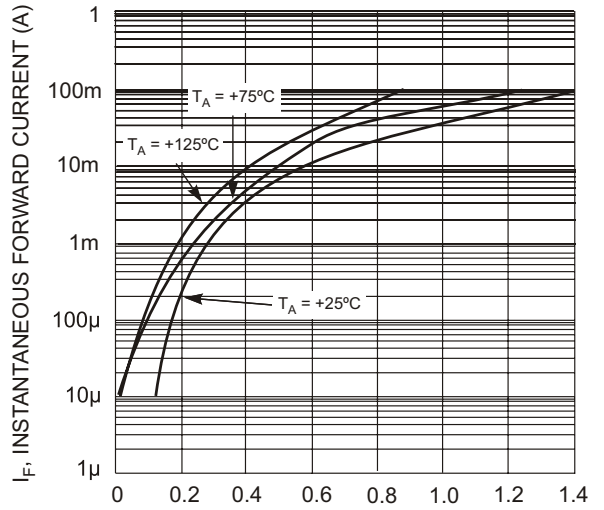

Fig. 2 Typical Forward Characteristics

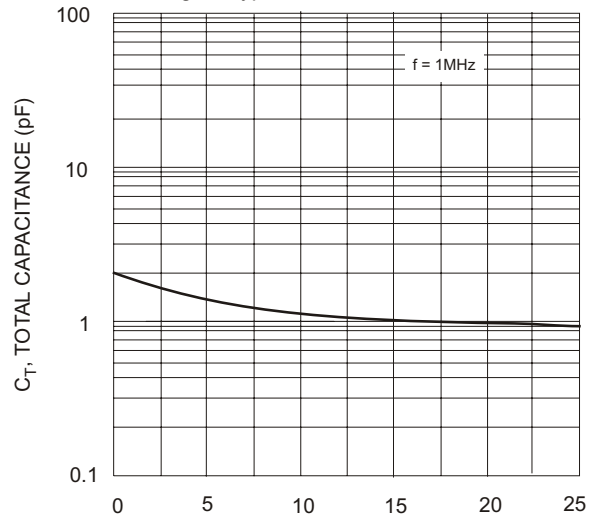

Fig. 4 Total Capacitance vs. DC Voltage

**Ordering Information** (Note 3)

Device	Packaging	Shipping
SDM03MT40-7	SOT-26	3000/Tape & Reel

Notes: 3. For Packaging Details, go to our website at <http://www.diodes.com/datasheets/ap02007.pdf>.

**Marking Information**

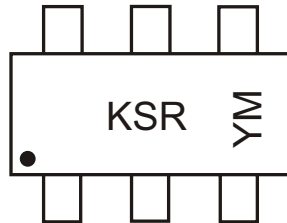

KSR = Product Type Marking Code  
 YM = Date Code Marking  
 Y = Year ex: N = 2002  
 M = Month ex: 9 = September

Date Code Key

Year	2002	2003	2004	2005	2006	2007	2008	2009
Code	N	P	R	S	T	U	V	W

Month	Jan	Feb	March	Apr	May	Jun	Jul	Aug	Sep	Oct	Nov	Dec
Code	1	2	3	4	5	6	7	8	9	O	N	D