

REMARK:

1. CHARACTERISTICS:

RATED VOLTAGE: 250V
 RATED CURRENT: 2.5AMP
 CONTACT RESISTANCE: 25mohms MAX. INITIAL,
 40mohms MAX. AFTER.
 INSULATION RESISTANCE: 5000mohms MIN. at 500V DC
 DIELECTRIC STRENGTH: 750VRMS
 OPERATING TEMPERATURE RANGE: -55° C~105° C
 INSERTION/EXTRACTION FORCE PER CONTACT: 5N Max./0.2N Min..
 MATING/UNMATING CYCLES: 200MATINGS MIN FOR GOLD-FLASH
 500MATINGS MIN FOR 30u" GOLD.

2. MATERIAL:

INSULATORS: THERMOPLASTIC G.F(UL94V-0) BLACK
 CONTACTS: COPPER ALLOY, GOLD(G/F or 30u") TOP OVER CONTACT
 AREA, 100u" Min MATTE TIN TOP OVER SOLDER AREA,
 50u" Min NICKEL UNDER PLATE.
 SHELL: CARBON STEEL, 100u" Min NICKEL TOP OVER,
 50u" Min COPPER UNDER PLATE.
 HARPOON: COPPER ALLOY , 100u" Min MATTE TIN PLATED

3. Type H Insulator will withstand exposure to 260° C peak temperature for 10 seconds maximum in a wave soldering application

4. PART NUMBER DESCRIPTION:

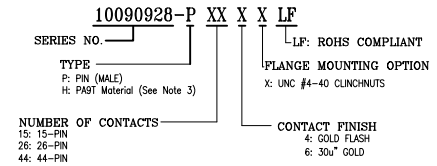

POS.	PART NO.	THREAD TYPE
15	10090928-P15*XLF	UNC #4-40
26	10090928-P26*XLF	UNC #4-40
44	10090928-P44*XLF	UNC #4-40

POS.	A	B	C	D	E	H
15	30.81	24.99	16.92	2.29	5.90 ^{+0.25} ₀	19.10
26	39.24	33.32	25.25	2.29	5.90 ^{+0.25} ₀	27.75
44	53.04	47.04	38.96	2.29	5.70 ^{+0.25} ₀	41.30

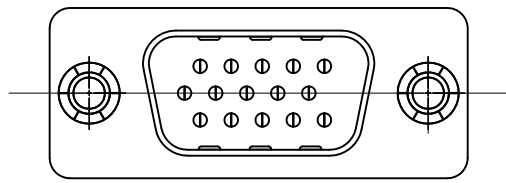

FOR 15P

mat'l. code		surface ISO 1302 ✓		tolerance ISO 406 ISO 1101		projection mm		product family D-SUB	
ltr		ecn no		dr		date		title	
E		ELX-1-20972		AB		2015/05/30		HD D-SUB MALE STRAIGHT	
F		ELX-1-25813		GREGAR		2016/10/31			
G		ELX-1-27111		MP		2017/05/27			
sheet		revision		G		G		G	
index		sheet		1		2		3	

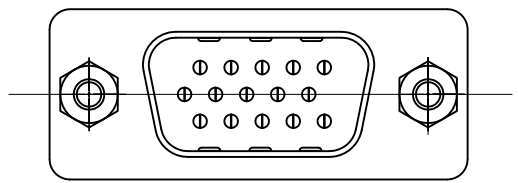
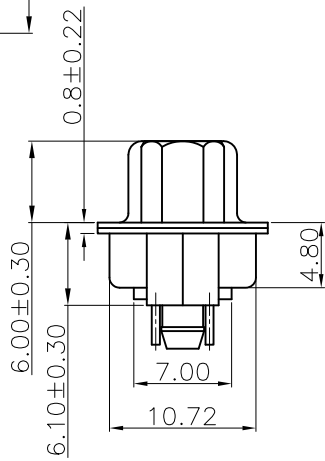
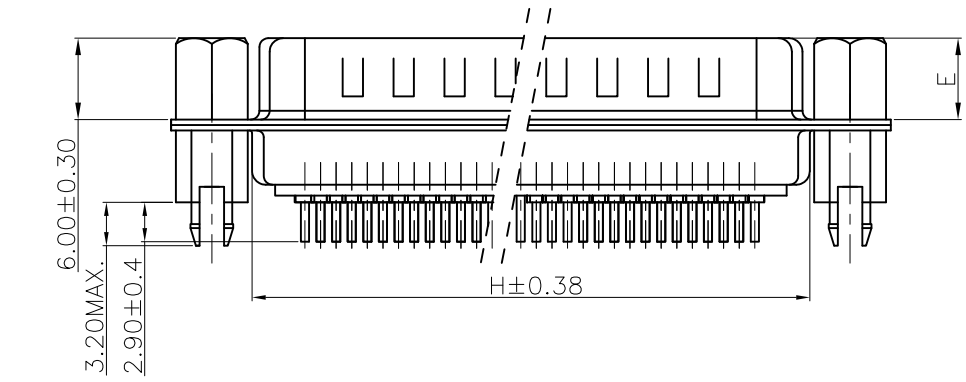
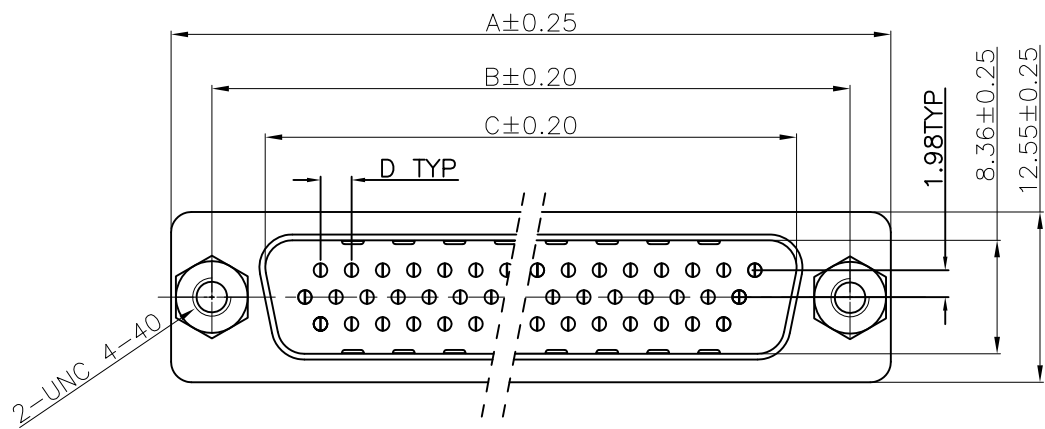

FOR 15P

REMARK:

- CHARACTERISTICS:
 RATED VOLTAGE: 250V
 RATED CURRENT: 2.5AMP
 CONTACT RESISTANCE: 25mohms MAX. INITIAL, 40mohms MAX. AFTER.
 INSULATION RESISTANCE: 5000Mohms MIN. at 500V DC
 DIELECTRIC STRENGTH: 750VRMS
 OPERATING TEMPERATURE RANGE: -55° C~105° C
 INSERTION/EXTRACTION FORCE PER CONTACT: 5N Max./0.2N Min.
 MATING/UNMATING CYCLES: 200MATINGS MIN FOR GOLD-FLASH 500MATINGS MIN FOR 30u" GOLD.
- MATERIAL:
 INSULATORS: THERMOPLASTIC G.F(UL94V-0) BLACK
 CONTACTS: COPPER ALLOY, GOLD(G/F or 30u") TOP OVER CONTACT AREA, 100u" Min MATTE TIN TOP OVER SOLDER AREA, 50u" Min NICKEL UNDER PLATE.
 SHELL: CARBON STEEL, 100u" Min NICKEL TOP OVER, 50u" Min COPPER UNDER PLATE.
 HARPOON: COPPER ALLOY, 100u" Min MATTE TIN PLATED.
 NUT: COPPER ALLOY, 50u" Min NICKEL PLATED.
- Type H Insulator will withstand exposure to 260° C peak temperature for 10 seconds maximum in a wave soldering application
- PART NUMBER DESCRIPTION:

10090928-P XX X V LF
 SERIES NO. _____ Lf: ROHS COMPLIANT
 TYPE _____ PLANGE MOUNTING OPTION
 P: PIN (MALE) _____ V: UNC #4-40 SCREWLOCKS
 H: PART Material (See Note 3)
 NUMBER OF CONTACTS _____ CONTACT FINISH
 15: 15-PIN _____ 4: GOLD FLASH
 26: 26-PIN _____ 6: 30u" GOLD
 44: 44-PIN _____

POS.	PART NO.
15	10090928-P15*VLF
26	10090928-P26*VLF
44	10090928-P44*VLF

POS.	A	B	C	D	E	H
15	30.81	24.99	16.92	2.29	5.90 ^{+0.25}	19.10
26	39.24	33.32	25.25	2.29	5.90 ^{+0.25}	27.75
44	53.04	47.04	38.96	2.29	5.70 ^{+0.25}	41.30

mat'l. code	surface ISO 1302 ✓	tolerance ISO 406 ISO 1101	projection mm	product family D-SUB
ltr	ecn no	dr	date	title
g				HD D-SUB MALE STRAIGHT
				scale N.T.S.
		dr	JASON HSU 2009/10/12	dwg no
		enr	MITHUN PAUL 2016/10/31	sheet 2 of 3
		chr	GREGAR MATHEW 2016/10/31	10090928
		app	BIJU K PAUL 2016/10/31	size A4
sheet index	revision sheet			type Product Customer Drawing

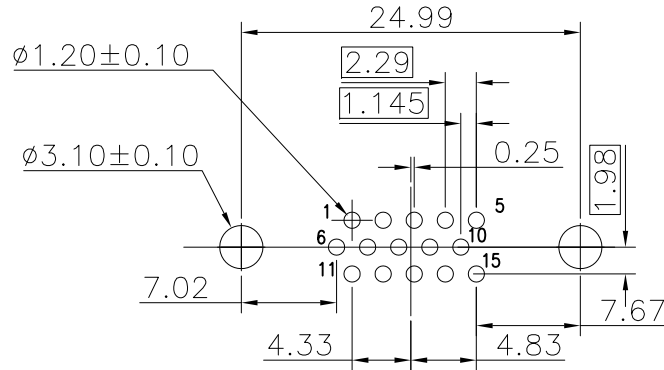

P.C.B LAYOUT (FOR 15P)

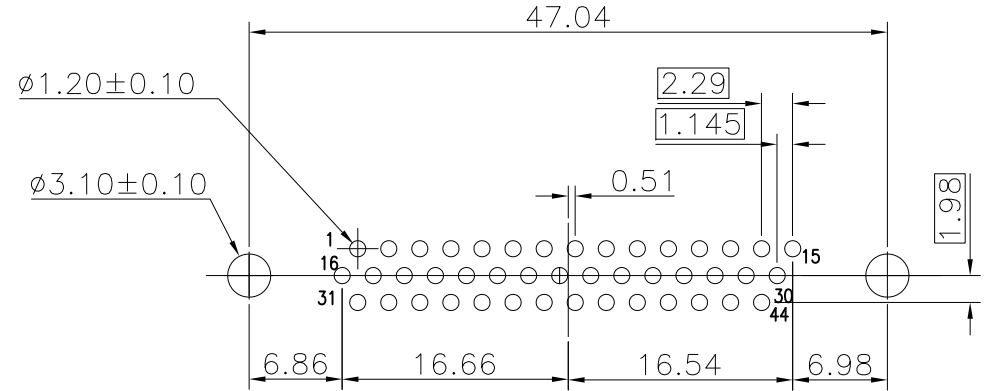

P.C.B LAYOUT (FOR 44P)

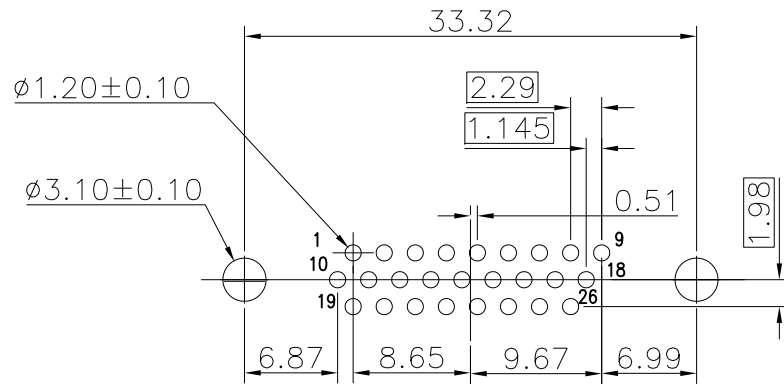

P.C.B LAYOUT (FOR 26P)

mat'l. code		surface ISO 1302 <input checked="" type="checkbox"/> ISO 406 ISO 1101		tolerance ISO 406 ISO 1101		projection 		product family D-SUB	
ltr		ecn no		dr		date		title	
g								HD D-SUB MALE STRAIGHT	
		angles		tolerances unless otherwise specified		mm		scale N.T.S.	
		0°±2'		.02±0.38		mm		dwg no	
				.00±0.25		mm		sheet 3 of 3 size	
				.000±0.010		mm		10090928 A4	
		dr		JASON HSU		2009/10/12		Amphenol FCi	
		engr		MITHUN PAUL		2016/10/31		dwg no	
		chr		GREGAR MATHEW		2016/10/31		10090928	
		appd		BIJU K PAUL		2016/10/31		type	
sheet index		revision sheet						Product Customer Drawing	