

# SRPE-03E1A0

## Non-Isolated DC-DC Converter

The Bel SRPE-03E1A0 is part of the non-isolated DC-DC converter power module series. The modules use a SMD package. These converters are available in a range of output voltages from 0.6 VDC to 5.5 VDC over a wide range of input voltage ( $V_{IN} = 5.5 \text{ VDC} - 13.2 \text{ VDC}$ ). The efficiency is typically 92% at 3.3 Vout ( $V_{in} = 12 \text{ VDC}$ ) at full load.

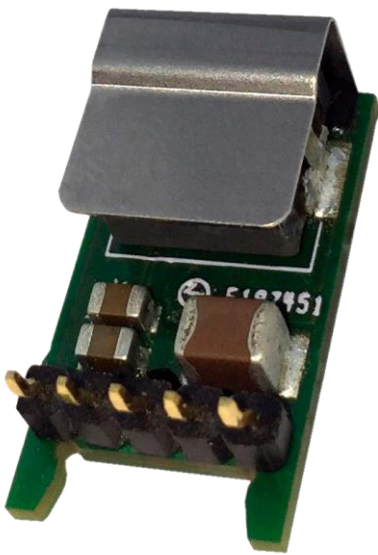

### Key Features & Benefits

- 5.5 VDC - 13.2 VDC Input
- 0.6 VDC - 5.5 VDC @ 3 A Output
- Non-Isolated
- High Efficiency
- Fixed Frequency
- Low Cost
- Wide Input
- Under-Voltage Lockout
- Wide Trim
- OCP/SCP
- Remote On/Off
- Class 2, Category 2 (refer to IPC-9592B)

### Applications

- Networking
- Computers and peripherals
- Telecommunications

## 1. MODEL SELECTION

MODEL NUMBER	OUTPUT VOLTAGE	INPUT VOLTAGE	MAX. OUTPUT CURRENT	MAX. OUTPUT POWER	TYPICAL EFFICIENCY
SRPE-03E1A0	0.6 V - 5.5 V	5.5 V - 13.2 V	3 A	16.5 W	92%

**NOTE:** Add "G" suffix at the end of the model numbers listed above to indicate "Tray Packaging".

### 1.1 PART NUMBER EXPLANATION

S	R	PE	- 03	E	1A	0	X
Surface mount	RoHS 6	Series name, SMD	Series code	Wide input range (5.5 - 13.2 V)	Wide output range (0.6 - 5.5 V)	Suffix	Package

## 2. ABSOLUTE MAXIMUM RATINGS

All specifications are typical at 25°C unless otherwise stated.

PARAMETER	DESCRIPTION	MIN	TYP	MAX	UNITS
Continuous non-operating Input Voltage		-0.3	-	15	V
Remote On/Off		-0.3	-	15	V
Ambient Temperature		0	-	50	°C
Storage Temperature		-55	-	125	°C
Altitude		-	-	2000	m

**NOTE:** Use beyond the maximum ratings may cause a reliability degradation of the converter or may permanently damage the device.

## 3. INPUT SPECIFICATIONS

All specifications are typical at 25°C unless otherwise stated.

PARAMETER	DESCRIPTION	MIN	TYP	MAX	UNIT
Input Voltage		5.5	-	13.2	V
Input Current (full load)	This power module is not internally fused. An input line fuse must always be used	-	-	2.6	A
Input Current (no load)		-	10	150	mA
Remote Off Input Current		-	1	5	mA
Input Reflected Ripple Current (rms)	With simulated source impedance of 1000 nH, 5 Hz to 20 MHz. Use a 1000 uF/25V AL-Cap with ESR = 0.03 ohm max and 2*100 uF/25 V	-	5	15	mA
Input Reflected Ripple Current (pk-pk)	Tan cap with ESR = 0.013 ohm max, at 100 KHz @ 25°C.	-	15	30	mA
I <sup>2</sup> t Inrush Current Transient		-	-	1	A <sup>2</sup> s
Turn-on Voltage Threshold		4.15	4.2	4.45	V
Turn-off Voltage Threshold		3.7	4	4.2	V

## 4. OUTPUT SPECIFICATIONS

All specifications are typical at 25°C unless otherwise stated.

PARAMETER	DESCRIPTION	MIN	TYP	MAX	UNIT
Output Voltage Set Point	$V_o, \text{ set} \geq 0.9 \text{ VDC}$	-2	-	2	% $V_{o,\text{set}}$
	$V_o, \text{ set} < 0.9 \text{ VDC}$	-3	-	3	% $V_{o,\text{set}}$
Load Regulation	$V_o \geq 3.3 \text{ VDC}$	-1.5	-	1.5	% $V_{o,\text{set}}$
	$V_o < 3.3 \text{ VDC}$	-20	-	20	mV
Line Regulation	$V_o \geq 3.3 \text{ VDC}$	-1.5	-	1.5	% $V_{o,\text{set}}$
	$V_o < 3.3 \text{ VDC}$	-15	-	15	mV
Regulation Over Temperature		-	0.8	-	% $V_{o,\text{set}}$
Output Ripple and Noise (pk-pk)	0-20 MHz BW, with 360 $\mu\text{F}$ ceramic capacitor at output.	-	20	50	mV
Output Ripple and Noise (rms)		-	5	20	mV
Output Current Range		0	-	3	A
Output DC Current Limit		3.5	4	6	A
Output Short-Circuit Current ( $V_o \leq 20 \text{ mV}$ ) (Hiccup Mode)		-	-	2	ADC
Rise time		-	2	2.5	ms
Turn On Time		-	3	5	ms
Overshoot at Turn on		-	0	3.5	%
Output Capacitance		200	-	1000	$\mu\text{F}$
<b>Transient Response</b>					
$\Delta V_{50\% \sim 100\%}$ of Max Load	Overshoot	-	30	60	mV
	Settling Time	-	20	50	us
$\Delta V_{100\% \sim 50\%}$ of Max Load	Overshoot	-	30	60	mV
	Settling Time	-	20	50	us

## 5. GENERAL SPECIFICATIONS

All specifications are typical at 25°C unless otherwise stated.

PARAMETER	DESCRIPTION	MIN	TYP	MAX	UNIT
Efficiency	5.5 V	92	94		%
	3.3 V	90	92		
	0.6 V	72	74		
Switching Frequency		-	650	-	kHz
Output Voltage Trim Range (Wide Trim)	This voltage is achieved by trimming up output slowly.	0.6	-	5.5	V
Weight		-	2.5	-	g
FIT	Calculated Telcordia SR-332, Issue 2 ( $V_{in} = 12 \text{ V}$ , $V_o = 5.5 \text{ V}$ , $I_o = 12 \text{ A}$ , $T_a = 40^\circ\text{C}$ , no forced air, 90% confidence Level, FIT = $10^9/\text{MTBF}$ )		16.8		-
Dimensions	Inches (L x W x H)	0.41 x 0.65 x 0.339			-
	Millimeters (L x W x H)	10.41 x 16.51 x 8.60			



Asia-Pacific  
+86 755 298 85888

Europe, Middle East  
+353 61 225 977

North America  
+1 408 785 5200

6. EFFICIENCY DATA

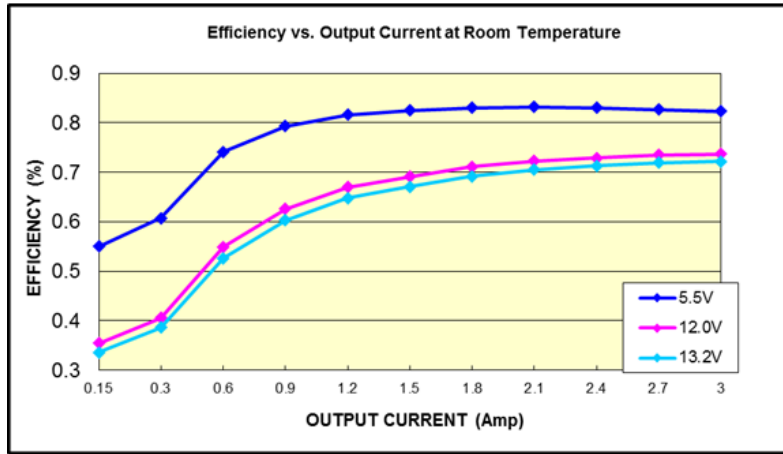

Figure 1. Vout: 0.6 V

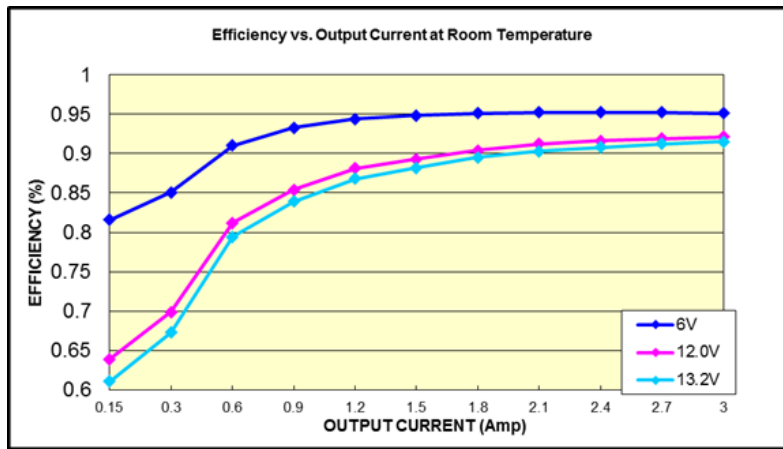

Figure 2. Vout: 3.3 V

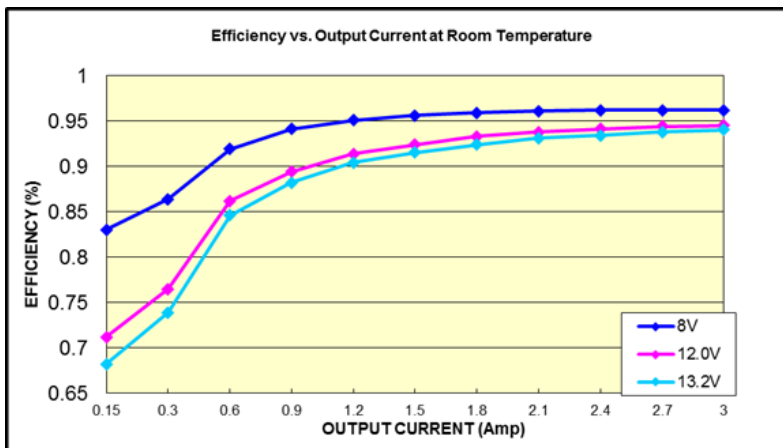

Figure 3. Vout: 5.5 V

### 7. INPUT UNDER-VOLTAGE LOCKOUT

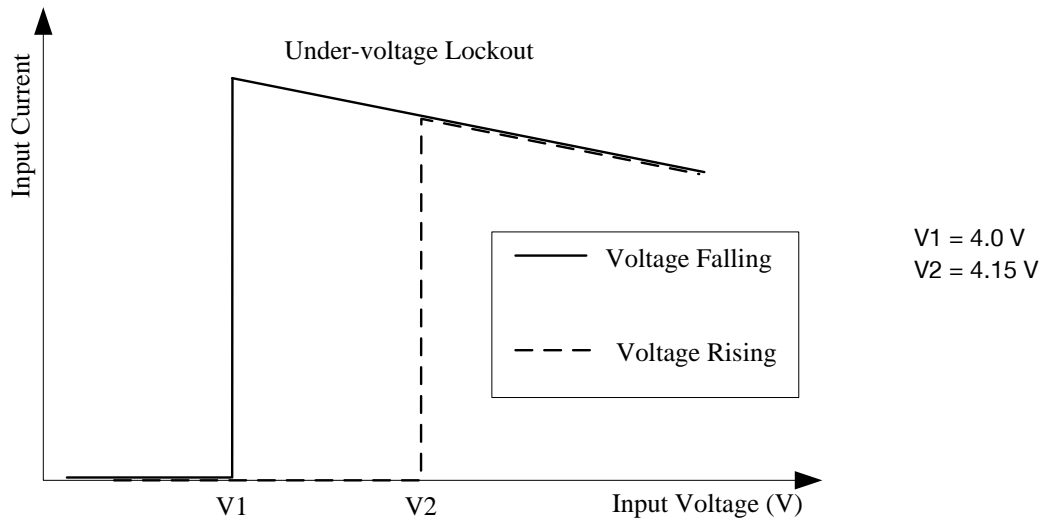

Figure 4. Input Under-Voltage Lockout

### 8. THERMAL DERATING CURVES

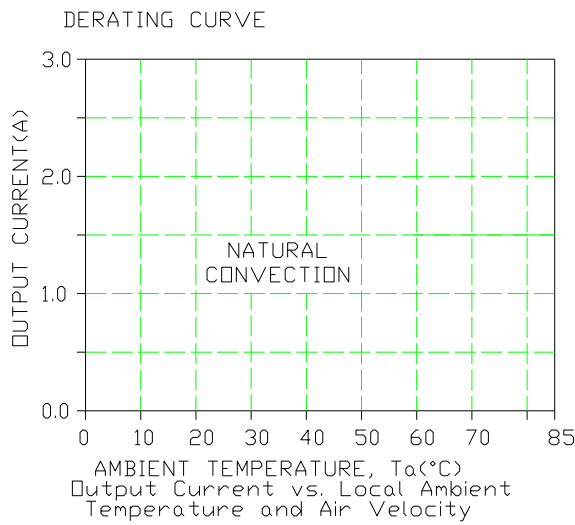
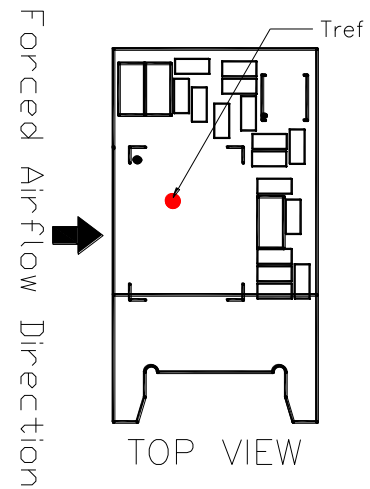

Figure 5.  $V_{out} = 0.6 - 5.5\text{ V}$



### 9. RIPPLE AND NOISE WAVEFORM

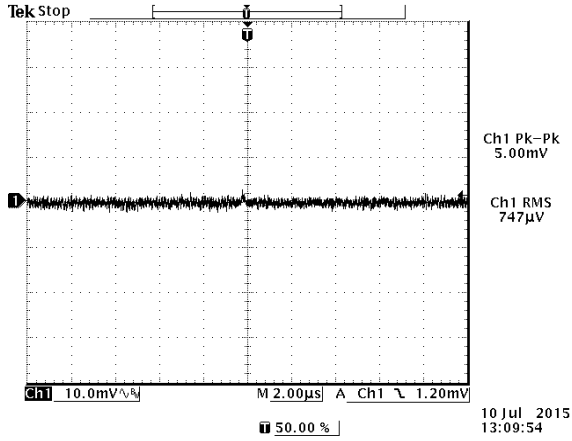

Figure 6. Ripple and noise at full load, 12 V input, 0.6 V output and  $T_a = 25^\circ\text{C}$

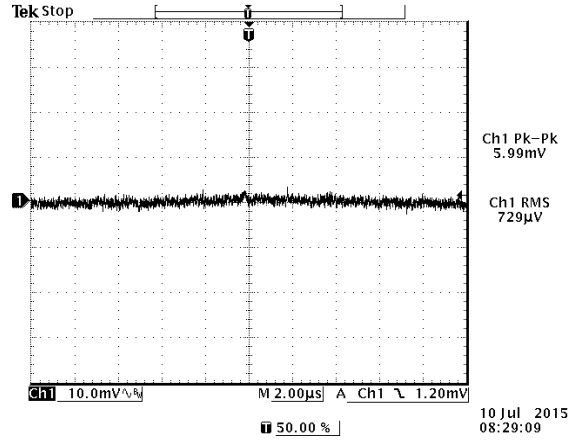

Figure 7. Ripple and noise at full load, 12 V input, 3.3 V output and  $T_a = 25^\circ\text{C}$

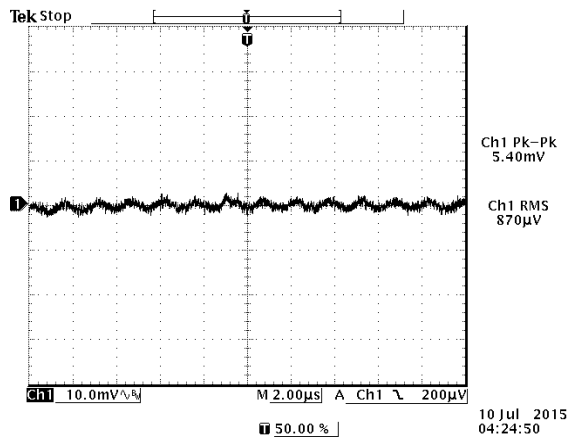

Figure 8. Ripple and noise at full load, 12 V input, 5.5 V output and  $T_a = 25^\circ\text{C}$

**NOTE:** Test condition of the output ripple and noise: 0-20 MHz BW with a 360 uF ceramic cap at output.

10. TRANSIENT RESPONSE WAVEFORMS

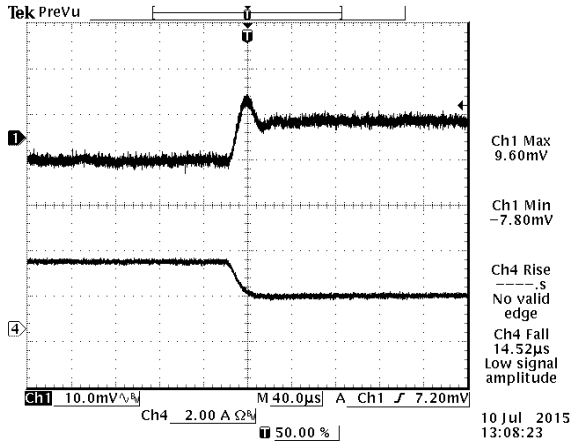

Figure 9. 100%-50% Load Transients at  $V_{in} = 12 V$ ,  $V_{out} = 0.6 V @ T_a = 25^{\circ}C$

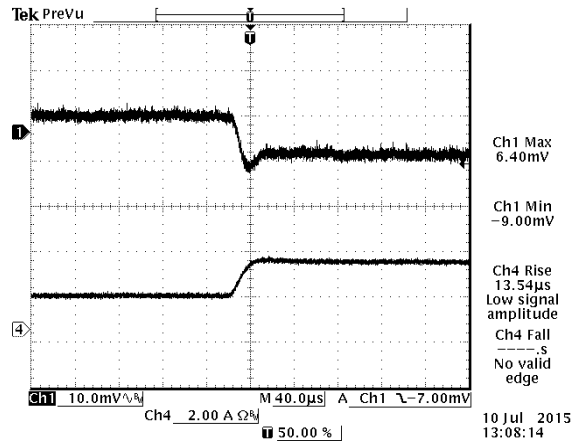

Figure 10. 50%-100% Load Transients at  $V_{in} = 12 V$ ,  $V_{out} = 0.6 V @ T_a = 25^{\circ}C$

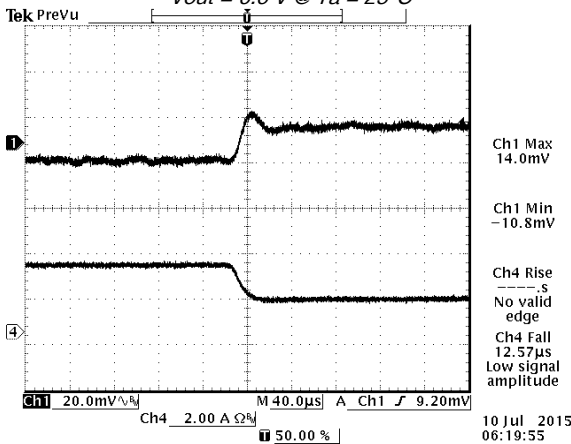

Figure 11. 100%-50% Load Transients at  $V_{in} = 12 V$ ,  $V_{out} = 3.3 V @ T_a = 25^{\circ}C$

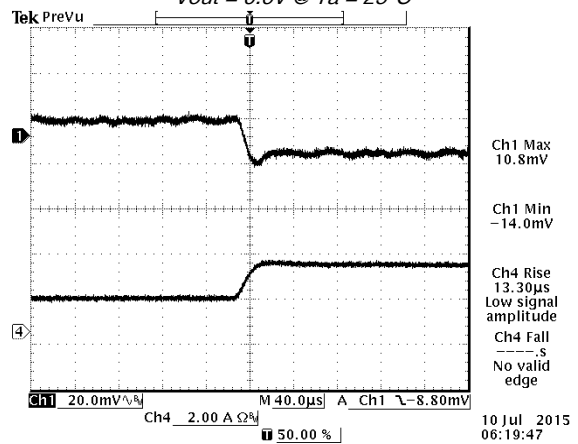

Figure 12. 50%-100% Load Transients at  $V_{in} = 12 V$ ,  $V_{out} = 3.3 V @ T_a = 25^{\circ}C$

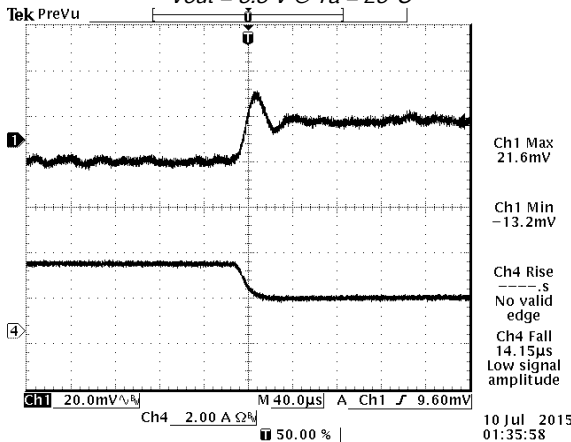

Figure 13. 100%-50% Load Transients at  $V_{in} = 12 V$ ,  $V_{out} = 5.5 V @ T_a = 25^{\circ}C$

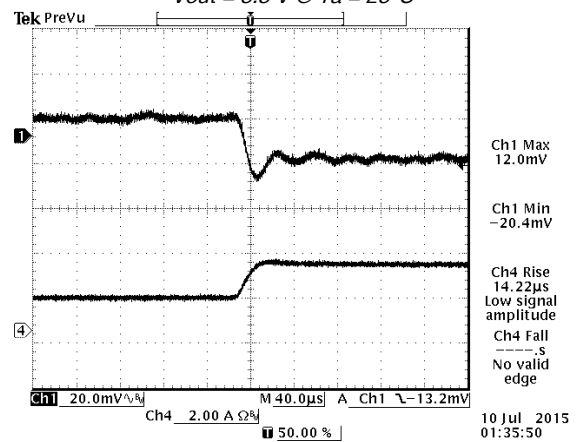

Figure 14. 50%-100% Load Transients at  $V_{in} = 12 V$ ,  $V_{out} = 5.5 V @ T_a = 25^{\circ}C$

NOTE: Test condition of the transient response:  $di/dt = 0.25 A/\mu s$ , with a 360  $\mu F$  ceramic cap at output



Asia-Pacific  
+86 755 298 85888

Europe, Middle East  
+353 61 225 977

North America  
+1 408 785 5200

### 11. REMOTE ON/OFF

PARAMETER	DESCRIPTION	MIN	TYP	MAX	UNIT
Signal Low (Unit Off)	Active High Remote On/Off pin is open, the module is off.	-0.3	-	0.8	V
Signal High (Unit On)		2.4	-	18	V

Recommended remote on/off circuit for active high

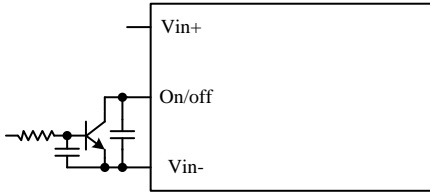

Figure 15. Control with open collector/drain circuit

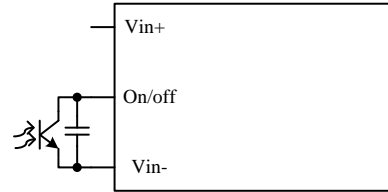

Figure 16. Control with photocoupler circuit

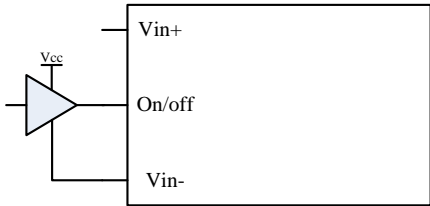

Figure 17. Control with logic circuit

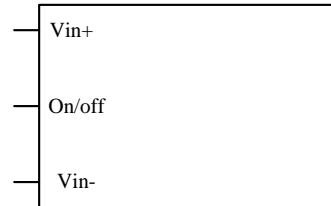

Figure 18. Permanently off

### 12. TRIM

Trim up circuit (using an external resistor)

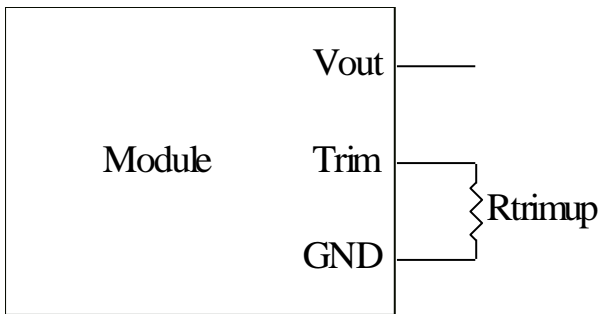
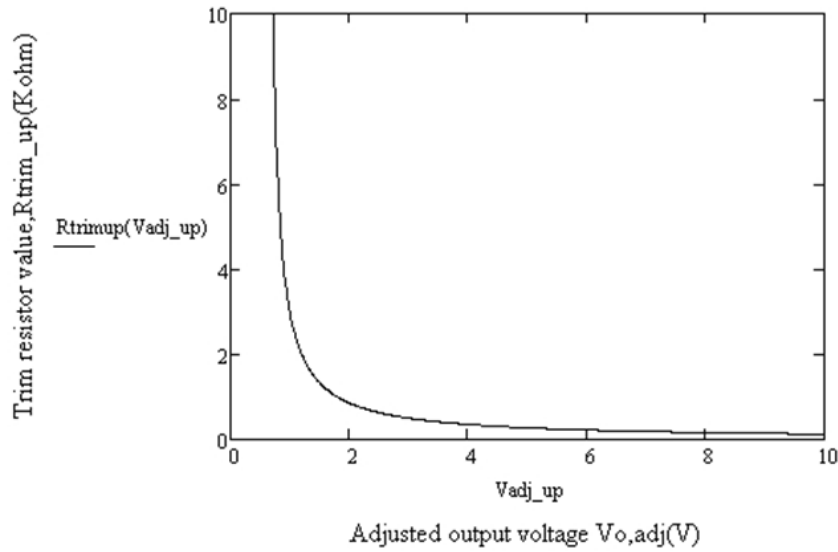

Figure 19. SRPE-03E1A0 Trim up Resistor Calculate

$$R_{trim} = \frac{1.2}{V_o - 0.6} k\Omega$$

Vo is the desired output voltage  
Rtrim is the required resistance between TRIM and GND





### 13. SOLDERING INFORMATION

The SRPE-03E1A0G modules are designed to be compatible with a Paste-In-Hole assembly process. The suggested Pb-free solder paste is Sn/Ag/Cu (SAC). The recommended reflow profile using Sn/Ag/Cu solder is shown in the following. Recommended reflow peak temperature is 245°C while the part can withstand peak temperature of 260°C maximum for 10 seconds. This profile should be used only as a guideline. Many other factors influence the success of SMT reflow soldering. Since your production environment may differ, please thoroughly review these guidelines with your process engineers.

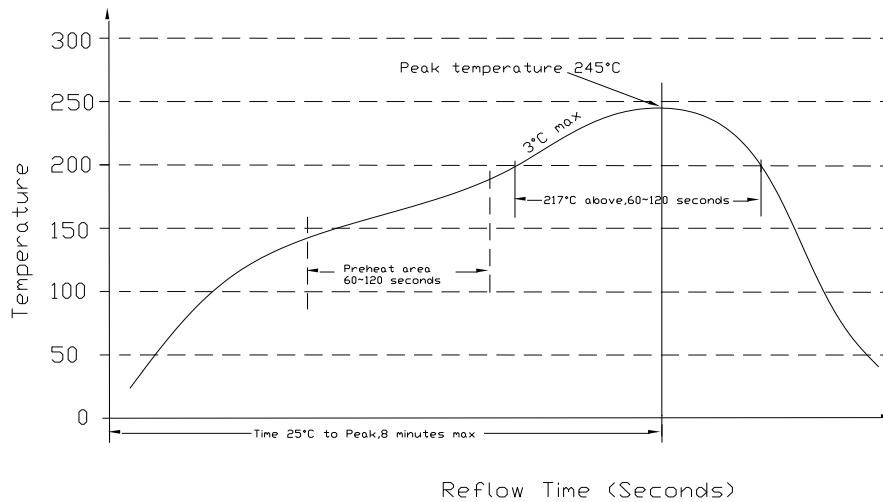

### 14. MSL RATING

The SRPE-03E1A0G modules have a MSL rating of 3.



Asia-Pacific  
+86 755 298 85888

Europe, Middle East  
+353 61 225 977

North America  
+1 408 785 5200

### 15. STORAGE AND HANDLING

The SRPE-03E1A0G modules are designed to be compatible with J-STD-033 Rev: A (Handling, Packing, Shipping and Use of Moisture /Reflow Sensitive surface Mount devices). Moisture barrier bags (MBB) with desiccant are applied. The recommended storage environment and handling procedure is detailed in J-STD-033.

### 16. PRE-BAKING

This component has been designed, handled, and packaged ready for pb-free reflow soldering. If the assembly shop follows J-STD-033 guidelines, no pre-bake of this component is required before being reflowed to a PCB. However, if the J-STD-033 guidelines are not followed by the assembler, Bel recommends that the modules should be pre-baked @ 120~125°C for a minimum of 4 hours (preferably 24 hours) before reflow soldering.

### 17. MECHANICAL DIMENSIONS

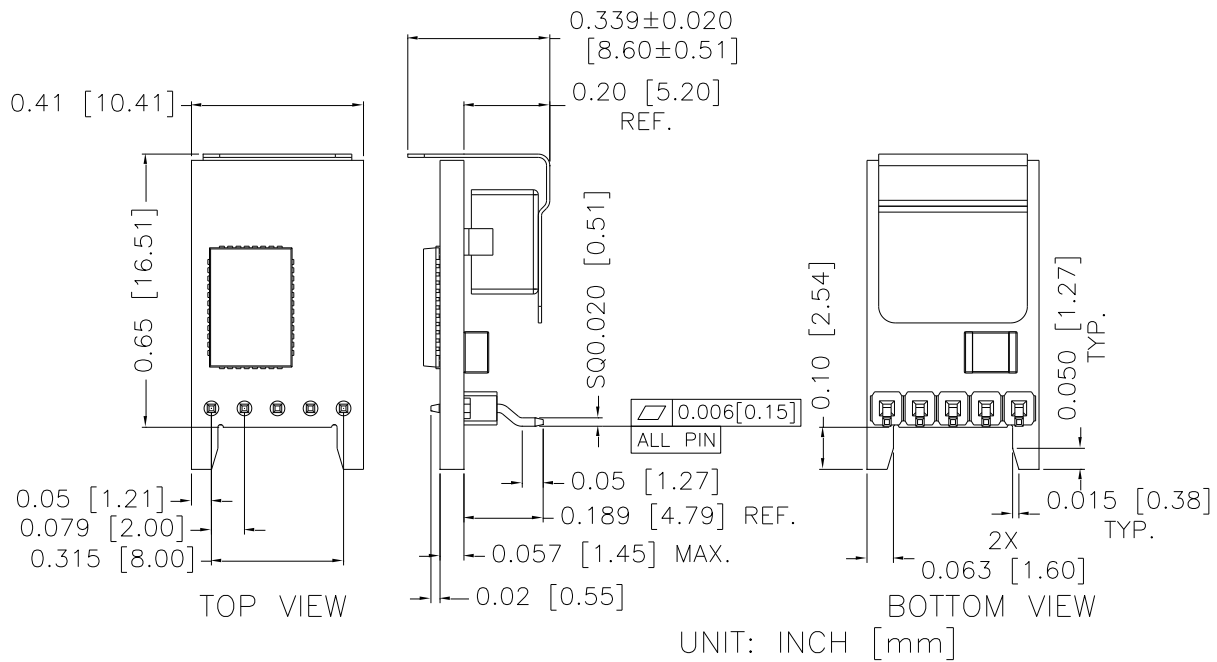

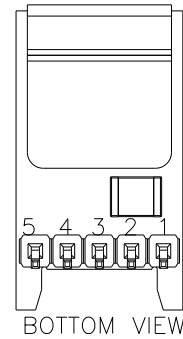
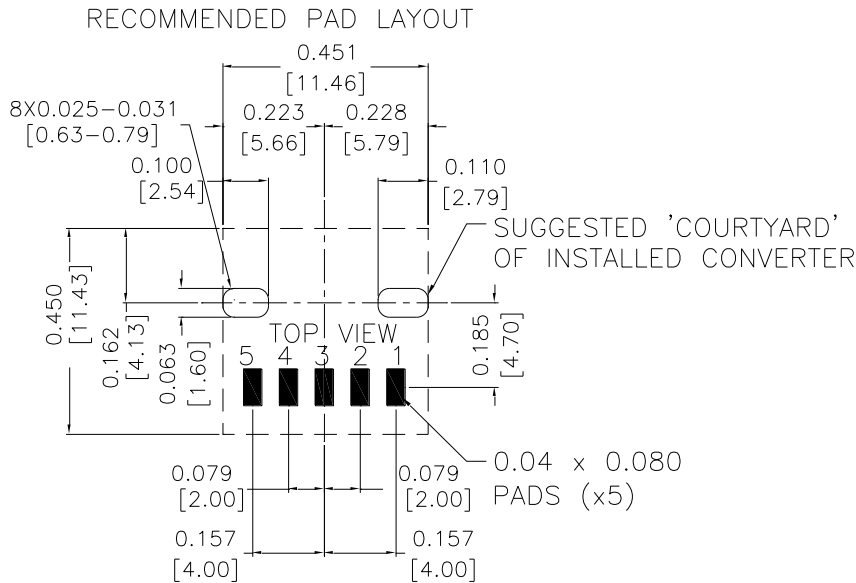

### PIN CONNECTIONS

PIN	FUNCTION
1	Enable
2	Vin
3	GND
4	Vout
5	Trim

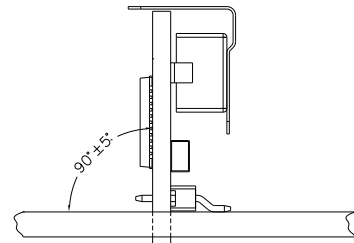
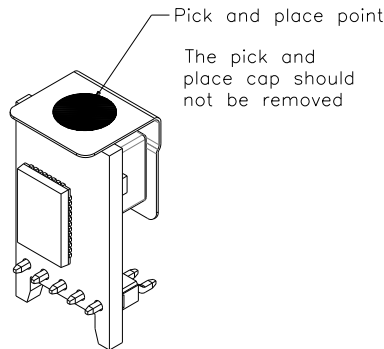

### NOTES:

- 1) All Pins: Material - Copper Alloy; Finish - 3 micro inches minimum Gold over 50 micro inches minimum Nickel plate.
- 2) Undimensioned components are shown for visual reference only.
- 3) All dimensions in inches (mm); Tolerances: x.xx +/-0.02 in [0.5 mm] x.xxx +/-0.010 in [0.25 mm].

For more information on these products consult: [tech.support@psbel.com](mailto:tech.support@psbel.com)

**NUCLEAR AND MEDICAL APPLICATIONS** - Products are not designed or intended for use as critical components in life support systems, equipment used in hazardous environments, or nuclear control systems.

**TECHNICAL REVISIONS** - The appearance of products, including safety agency certifications pictured on labels, may change depending on the date manufactured. Specifications are subject to change without notice.



Asia-Pacific  
 +86 755 298 85888

Europe, Middle East  
 +353 61 225 977

North America  
 +1 408 785 5200